

Document Name	Document No.	Date	Page
ER14250S Specification	ZJQM-RD-SPC-H1132	2019-11-12	1/8

EEMB BATTERY

Lithium Thionyl Chloride Battery



Specification

锂亚硫酰氯电池

产品规格书

High Temperature Type

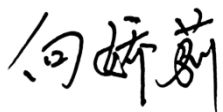
Model 型号:	ER14250S
Capacity 容量:	600mAh

Prepared 编制	Checked 审核	Approved 批准
		

Customer 客户名称:

Customer Approval (Customer confirmation) 客户确认:

Address: 6/F, Block 110, Jindi Industrial Zone, Sha Tou Street, Futian District, Shenzhen, China

Postal code: 518048

Phone: +86-755-83022275

FAX: +86-755-83021966

<https://www.eemb.com>



Document Name	Document No.	Date	Page
ER14250S Specification	ZJQM-RD-SPC-H1132	2019-11-12	2/8

Catalog

Chapter	Content	Page
0	Catalog.....	2
1	Scope.....	4
2	Features and Applications.....	4
3	Battery Basic Characteristics.....	4-5
4	Battery Cell Shape and Dimensions.....	5
5	Appearance.....	6
6	Characteristics Curve.....	6-7
7	Memory Backup Circuit Design Suggestion	7
8	Matters Needing Attention.....	7-9

Document Name	Document No.	Date	Page
ER14250S Specification	ZJQM-RD-SPC-H1132	2019-11-12	3/8

1. Scope 适用范围

This product specification defines the requirements of the Lithium Thionyl Chloride battery supplied to the customer by EEMB.

本产品规格书适用于 EEMB 提供的锂亚硫酰氯电池。

2. Features and Applications 功能和应用

Features 功能:

- ✓ Excellent shelf life (10 years at room temperature). 保质期长（室温下 10 年）。
- ✓ Low self-discharge (2% or less per year). 自放电率低（每年 2% 或更低）。
- ✓ Suited for long-term use with low current. 适合长期低电流使用。
- ✓ Best suit for low current discharge. 最适合低电流放电。
- ✓ Wide temperature range from -20°C to +150°C. 温度范围广，-20°C ~ +150°C。。

Applications 应用:

Physical detection and NC wells detection tool 物理检测和 NC 井检测工具

Data acquisition instrument 数据采集仪器

Electronic testing instrument 电子测试仪器

Aerospace equipment 航天设备

3. Battery Basic Characteristics 电芯产品基本特性

No. 序号	Item 项目	Characteristics 特性	Remark 备注
3.1	Model 型号	ER14250S	
3.2	Nominal Capacity 标称容量	600mAh	*1
3.3	Nominal Voltage 标称电压	3.6V	
3.4	Max. Continuous Discharge Current 最大连续放电电流	50mA	
3.5	Max. Pulse Current 最大脉冲放电电流	100mA	
3.6	Weight 重量	Approx.10g	
3.7	Self-discharge Rate 自放电率	≤ 2%	
3.8	Operating Temperature 工作温度	-20°C~+150°C	*2
3.9	Storage Life 储存寿命	10 years	
3.10	Storage (Recommended) 存储（建议）	≤ 30°C	

*1: At 23°C ± 2°C, 10 mA discharge to end-off voltage of 2.0V.

23°C ± 2°C 时, 10 mA 放电至终止电压 2.0V。

*2: When the operating temperature is higher or lower than the normal temperature, the discharge capacity and

Document Name	Document No.	Date	Page
ER14250S Specification	ZJQM-RD-SPC-H1132	2019-11-12	4/8

the initial pulse voltage of the battery are reduced.

使用温度高于或低于常温，电池的放电容量及脉冲初始电压均会降低。

Note 备注:

- ✓ For high rate discharge, the maximum operational temperature has to be lowered.
对于高速率放电，必须降低最高工作温度。
- ✓ Battery performance and battery capacity is function of current drain, temperature and cut off voltage.
电池性能和电池容量是电流消耗，温度和截止电压的函数。
- ✓ Energy Type (bobbin structure) battery has very low self discharge on the shelf and during operation. It is best suited for low current discharges. It may require depassivation before medium currents can be delivered.
能量类型（线轴结构）电池在储存和工作期间具有非常低的自放电。它最适合低电流放电。在输送中等电流之前可能需要去钝化。
- ✓ In order to calculate precise life time under various environments, as well as use battery in a safer way, we recommend you to consult EEMB.
为了在各种环境下计算精确的使用寿命，以及以更安全的方式使用电池，我们建议您咨询 EEMB。

4. Battery Cell Shape and Dimensions (Unit: mm)

产品外形及尺寸（单位：mm）

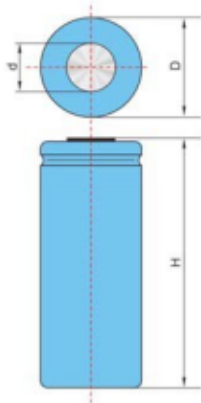

Item 项目	Specification 规格
D	Max.14.65
H	Max.25.2

5. Appearance 外观

It shall be free from any defects such as remarkable scratches, breaks, cracks, discoloration, leakage, or middle deformation.

电池表面无划伤、裂纹、脏点、锈蚀、变形、变色、漏液等缺陷，中间无翘起。

6. Characteristics Curve 特征曲线

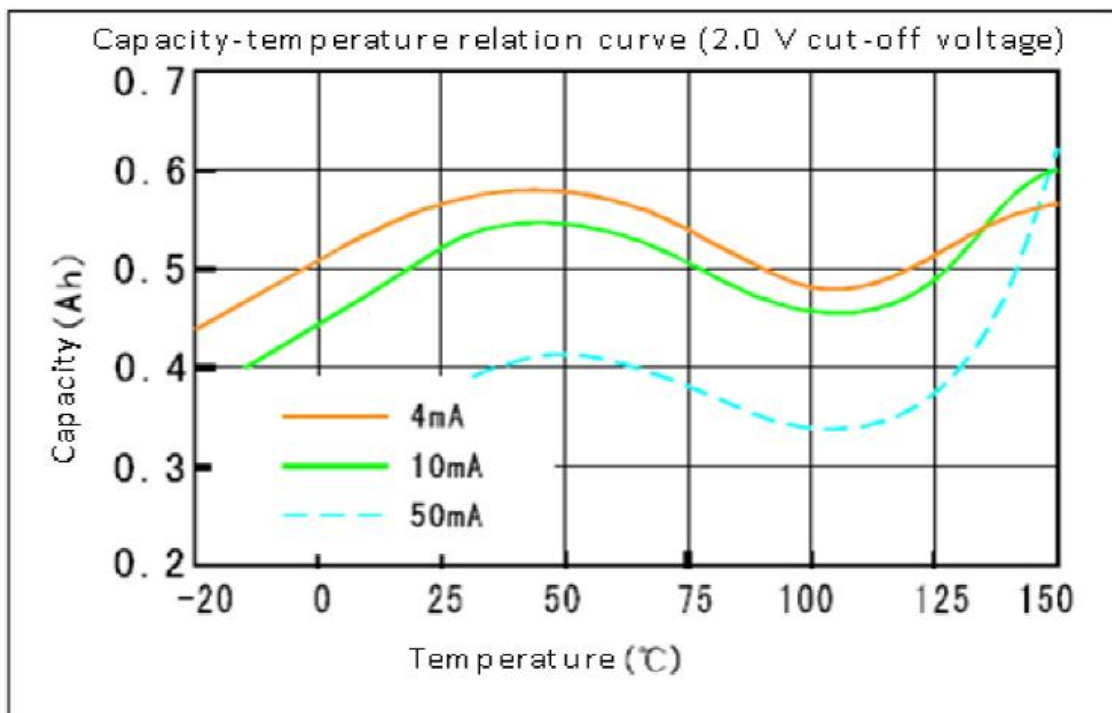
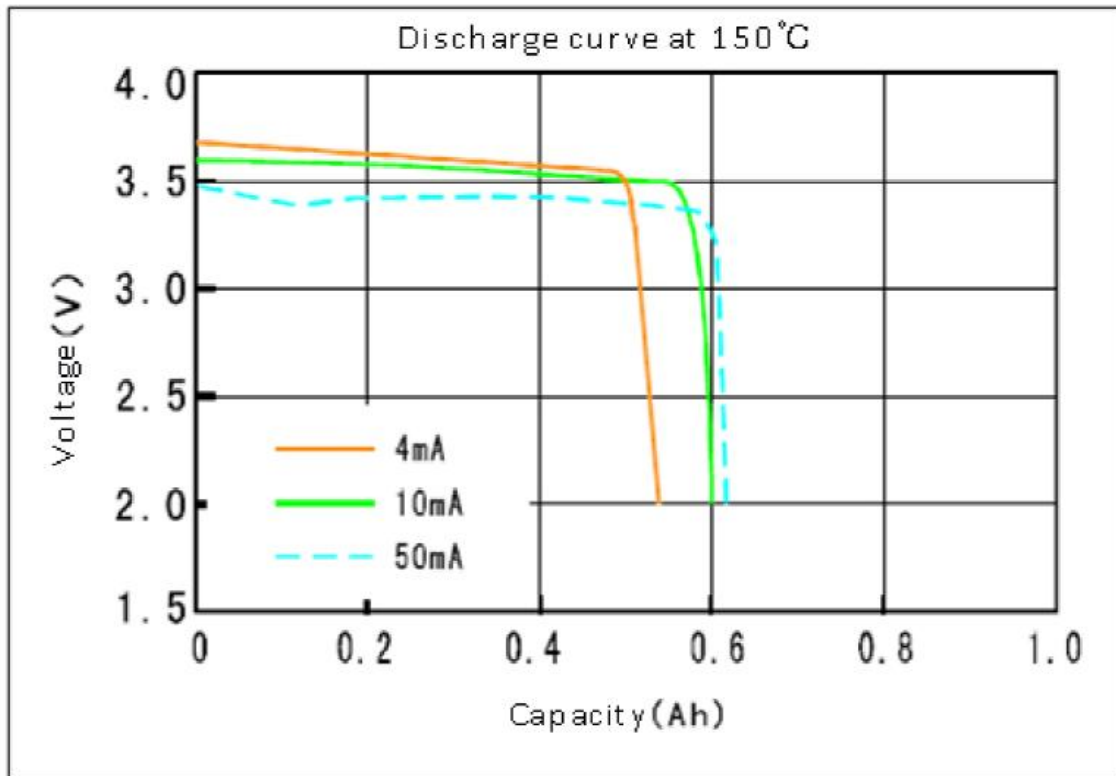

Document Name	Document No.	Date	Page
ER14250S Specification	ZJQM-RD-SPC-H1132	2019-11-12	6/8

A primary lithium battery is not rechargeable, when used for memory backup in combination with another power source; current may flow into the battery from the other source. A protection diode and resistor into the circuit is needed to avoid battery charging or over discharging. Select a silicon diode or a diode with minimum leakage current, and design the circuit so that the amount of charging due to leakage current will not exceed 2% of the nominal battery capacity over the total period of use.

当与另一个电源组合用作存储器备份时，一次锂电池不可再充电；电流可能从另一个源流入电池。需要在电路中使用保护二极管和电阻器以避免电池充电或过度放电。选择硅二极管或具有最小漏电流的二极管，并设计电路，使漏电流引起的充电量不超过总使用时间内电池标称容量的 2%。

While used for memory backup, the following circuit shall be applied:

用于内存备份时，应使用以下电路：

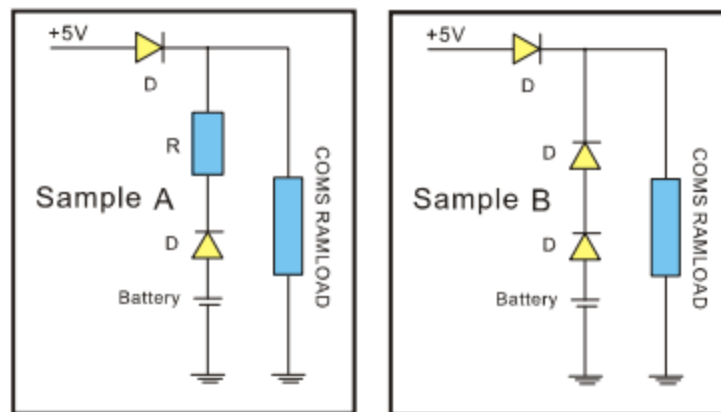

8. Matters Needing Attention 注意事项

Strictly observes the following needing attention. EEMB will not be responsible for any accident occurred by handling outside of the precautions in this specification.

严格遵守以下注意事项。对于因本规范中的预防措施之外的操作而发生的任何事故，EEMB 概不负责。

! Caution 注意

- ✓ Use Nickel-plated iron or Nickel-plated stainless steel for the terminals that contact the battery.
使用镀镍铁或镀镍不锈钢作为接触电池的端子。
- ✓ Make sure that terminal contact pressure is 50g minimum, for a stable contact.
确保端子接触压力最小为 50g，以确保稳定接触。
- ✓ Keep the battery and contact terminal surfaces clean and free from moisture and foreign matter.
保持电池和接触端子表面清洁，避免受潮和异物进入。
- ✓ Before inserting the battery, check the battery contact terminals to make sure they are normal, not bent or damaged. (Bent terminals may not make good contact with the battery or may cause short circuit.)
在插入电池之前，请检查电池接触端子，确保它们正常，没有弯曲或损坏。（弯曲的端子可能与电池接触不良或可能导致短路。）
- ✓ When the batteries are piled up in a disorderly way, their positive and negative terminals may short-circuit, consuming some batteries while charging others, causing explosion.
当电池无序堆积时，它们的正极和负极可能会短路，在给其他电池充电时消耗一些电池，从而导致爆炸。
- ✓ Lithium batteries that are almost exhausted can output a voltage that is almost the same as that of a new

Document Name	Document No.	Date	Page
ER14250S Specification	ZJQM-RD-SPC-H1132	2019-11-12	7/8

battery, please do not judge a battery only with a Voltmeter. Avoid using a mixture of old and new batteries; replace all batteries in a set with new one.

快用完的锂电池可以输出与新电池几乎相同的电压，请不要仅用电压表判断电池。避免新旧电池混用；用新的电池更换一套旧电池。

- ✓ Lithium batteries need a period of time to recover their normal voltage after even a slight short circuit. Therefore, if the battery is short-circuited, wait an adequate long time for batteries to recover before measuring their electrical characteristics.
即使是轻微的短路，锂电池也需要一段时间才能恢复正常电压。因此，如果电池短路，请在测量电气特性之前等待足够长的时间让电池恢复。
- ✓ Use a high impedance (1M or higher) voltmeter to measure battery voltage.
使用高阻（1M 或更高）电压表测量电池电压。
- ✓ Battery characteristics vary with type and grade, even when batteries are the same size and shape. When replacing batteries with new ones, be sure to carefully check the symbols and numbers on them.
即使电池尺寸和形状相同，电池特性也会因型号和等级而异。更换新电池时，请务必仔细检查电池上的符号和数字。

! Danger 危险

- ✓ DO NOT recharge, short-circuit, disassemble, deform, heat or place the battery near a direct flame. This battery contains flammable materials such as lithium and organic solvent and performing any of the above actions could cause it to ignite explode or become damaged.
请勿在直接火焰附近充电，短路，拆卸，变形，加热或放置电池。该电池含有易燃材料，如锂和有机溶剂，上述任何操作都可能导致其爆炸或损坏。
- ✓ DO NOT over-discharge the battery. In case the battery is over-discharged battery has potential of explosion. In case battery is over discharged, when connected with exterior power source or connected with other batteries in series, explosion may occur.
请勿过度放电。如果电池过度放电，电池可能会爆炸。如果电池过放电，当与外部电源连接或与其他电池串联时，可能会发生爆炸。
- ✓ Keep this battery out of the reach of children. If it is swallowed, contact a physician immediately.
请将此电池放在儿童接触不到的地方。如果吞下，请立即联系医生。
- ✓ When storing a battery or throwing it away, be sure to cover it with tape. If the battery is contacted with other metal objects, it could cause fire or become damaged.
存放电池或丢弃电池时，请务必用胶带包住电池。如果电池与其他金属物体接触，可能会引起火灾或损坏。

! Warning 警告

- ✓ Thoroughly read the user's manual before use, inaccurate handling may cause leakage, heat, smoke, explosion, or fire, causing device trouble or injury.
使用前请仔细阅读用户手册，不准确的操作可能会导致泄漏，发热，冒烟，爆炸或起火，从而导致设备故障或人员受伤。
- ✓ Insert the battery with the "+" and "-" ends correctly oriented.
插入电池时，注意“+”极和“-”极方向正确。
- ✓ If the battery is used together with new batteries, do not use it with a different type battery.
如果电池与新电池一起使用，请勿将其与其他类型的电池混用。
- ✓ Do not solder the battery directly.



Document Name	Document No.	Date	Page
ER14250S Specification	ZJQM-RD-SPC-H1132	2019-11-12	8/8

请勿直接焊接电池。

- ✓ Avoid storing the battery in direct sunlight, or in excessively hot and humid place.
避免将电池存放在阳光直射或过热和潮湿的地方。

EEMB reserves the final explanation. Please use battery strictly according to specification. EEMB will not be responsible for any inappropriate operation. EEMB keeps the right to change product specifications without previous notice. If any question, please consult with the manufacturer

EEMB 保留最终解释权。请严格按照规范使用电池。EEMB 对任何不当操作将不负责。EEMB 保留修改产品规格书不另行通知的权利。如有任何问题, 请咨询制造商。